

# Overhead Distribution Transformers

5-833 kVA Single Phase  
30-500 kVA Three Phase



Represented by and  
Nameplated for ABB Inc.



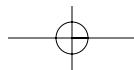
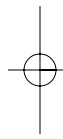
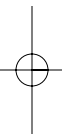
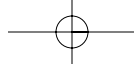

## About Power Partners, Inc.

Power Partners, Inc. manufactures poletype distribution transformers that provide more than 3,000 utilities in North America, Central America, the Middle East and Asia with electric power for homes and businesses. Power Partners' poletype distribution transformers are specifically designed to serve residential overhead distribution loads. They are also suitable for light commercial loads, industrial lighting, and diversified power applications.

Power Partners provides a complete line of overhead transformers to meet the applications of any distribution system. The company manufactures single-phase and three-phase poletype transformers at 34.5 kV and below, in ratings from 5-833 kVA single-phase and 30-500 kVA three-phase. The Power Partners core-coil design provides optimum efficiency and excellent mechanical, thermal and electrical performance.

The Power Partners operation in Athens, GA, has achieved ISO 9001: 2000 certification. The operation, which was an ABB facility until Power Partners purchased it in May 2003, has nearly 50 years of manufacturing experience.

## The ABB Connection

The poletype distribution transformers manufactured by Power Partners are name-plated for ABB, with ABB serving as the manufacturer's representative for Power Partners. ABB is a global leader in power and automation technologies that enable utility and industry customers to improve their performance, while lowering their environmental impact.

## Manufacturing Technology

Overhead distribution transformers manufactured by Power Partners offer cost-effective solutions for power distribution. The latest manufacturing technology is utilized to maintain state-of-the-art quality and productivity. Large vertical integration allows us to ship high quality products in the shortest possible production cycle.



## The Value of Quality

Power Partners is committed to achieving total customer satisfaction and industry leadership through continuous process improvement. The company's employees are team-based and measurement focused, and their work is based on highly disciplined processes. The company is innovative, reliable and driven to provide high quality and high value, and to meet each delivery commitment. We want Power Partners to be recognized as a company that exceeds customers' expectations.

## An Industry Leader

Working together with ABB as the manufacturer's representative for Power Partners, we have alliances with major utilities and businesses around the world providing products and services to meet all their needs. Together, we are a dominant force in the industry.

## Single Phase Overhead Distribution Transformers

Power Partners single phase, oil-filled, pole-mounted distribution transformers are specifically designed for servicing residential overhead distribution loads. They are also suitable for light commercial loads, industrial lighting and diversified power applications. These transformers are designed for the application conditions normally encountered on electric utility power distribution systems.



### Ratings

- 5-833 kVA
- 65° C temperature rise
- 60 hertz standard, 50 hertz optional
- Low voltages: 120/240, 240/480 and 277
- High voltages: 2400 through 34,400 Volts
- Insulation levels:

Rated Voltage Ranges	Insulation Class	Basic Impulse Level (kV)
480-600	1.2	30
2160-2400	5.0	60
4160-4800	8.7	75
7200-12470	15.0	95
<i>Optional 125 kV BIL 12000 volts available.</i>		
13200-14400	18.0	125
19920-22900	25.0	150
<i>Optional 125 kV BIL 19920 volts available.</i>		
-34400	34.5	200

### Standard Features:

1. Lifting lugs.
2. Arrester mounting pads.
3. Cover-mounted high voltage porcelain bushing(s) with eyebolt terminal (10-100 kVA) or spade terminal.
4. Low voltage insulators are available in fiberglass reinforced polyester material or porcelain (both eyebolt and spade terminals).
5. Low voltage neutral grounding strap (furnished on 10-50 kVA single HV bushing units).
6. ANSI support lugs (hanger brackets).
7. Cover has 13 mils minimum of polyester coating providing 15 kV dielectric insulation of tank ground parts from live parts and increased resistance to corrosion.
8. Self-venting and resealing cover assembly.
9. The core/coil bolt-in pads are 180° apart.
10. Embossed low voltage leads.
11. Oil filled plug with cover ground strap.
12. Tank ground pad.

13. Laser etched anodized aluminum nameplate with bar coded serial number.
14. The paint finish process applies a durable, corrosion resistant finish to the product. The finish meets or exceeds all the performance requirements of ANSI C57.12.28. The multi-step process includes an epoxy primer uniformly applied by cationic electro-deposition and a urethane top coat.

The following additional features are all standard on self-protected type CSP® units:

15. Primary protective link.
16. Surge arrester.
17. Secondary circuit breaker.
18. Secondary breaker operating handle with emergency overload reset and overload signal light.



### Options

#### Primary Termination

- Cover-mounted high voltage porcelain bushing(s) with spin top terminal.
- Side-wall mounted high voltage porcelain bushing(s) with spin top terminal (Standard on all 4800 volts and below).
- Primary current limiting backup fuse.

#### Secondary Termination

- Low voltage porcelain bushings with NEMA spade terminals (Standard on all units 167 kVA and above).

#### Primary Switching

- Externally-operated tap changer.
- Externally-operated dual voltage switch or internal terminal board.

#### Overcurrent Protection

- Internally-mounted current limiting fuse in series with protective link.

Contact the division for voltages and dimensions on 666 through 833 kVA.

### Optional Accessories

1. High voltage bushings are of two types and are made of wet process porcelain:
  - Speed wrench operable eyebolt bushing for cover mounting.
  - Spin-top bushings for either cover or side-wall mount.
2. Tap changers compensate for small voltage variations along the distribution system. The externally-operated tap changer is a single-phase, five-position design for de-energized operation.

3. A dual voltage switch permits use of the same transformer on distribution systems with different system voltages.
4. The CSP® protection package consists of four related components that work together to provide complete self-contained protection against surge currents, short circuits and overloads:
  - The protective link removes an internally-faulted transformer from the primary line, maintaining service to other customers on the line not served by the faulted unit.
  - The MOV polymer arresters handle surges of 65,000 amperes (small block) and 100,000 amperes (large block).
  - Secondary circuit breakers protect against overloads and external short circuits.
  - An optional current limiting fuse supplements the protective link when the fault current exceeds the link's rating.
5. Stainless steel tanks and covers are available.

**Overhead Distribution Transformers**

Approximate weights and dimensions

Standard Design Dimensions and Weights  
(All weights and dimensions are approximate. Dimensions may change to meet the customer spec.)

Single Phase, 60 HZ, OISC, 65° Rise High Voltage

(Refer to Division for available tap positions and dimensions for other primary voltages.)

Low Voltage 120/240 or 240/480 or 277 Standard Performance level

APPROXIMATE WEIGHTS AND DIMENSIONS OVERHEAD DISTRIBUTION TRANSFORMERS

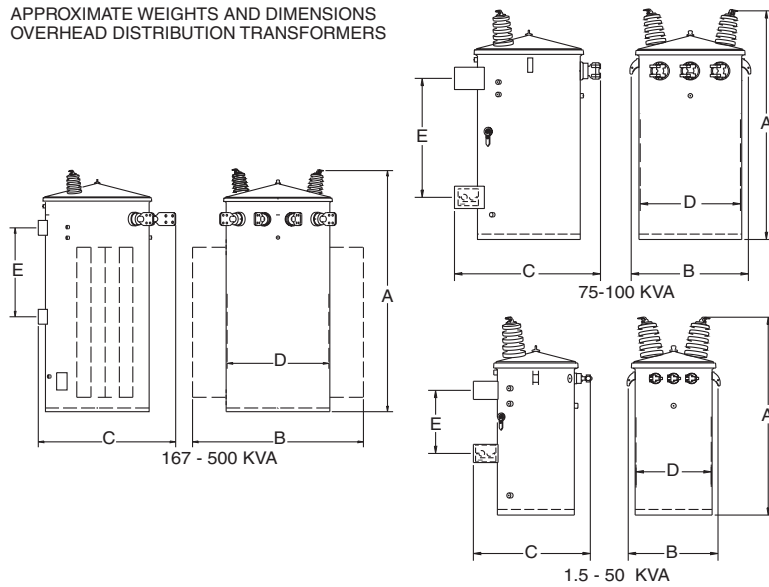

Overall weights and dimensions are given in pounds, inches or gallons and are approximate  
A = Overall Height, B = Overall Width, C = Overall Depth, D = Tank Diameter, E = Hanger Spacing

1 Phase								
Type 'S' - Class 0A - 7200 /12470Y Primary Voltage								
KVA	A	B	C	D	E	Wgt	Ship Wgt	OIL Qty
10	34	17	20	13.25	11.25	205	217	11
15	36	17	20	13.25	11.25	236	247	12
25	41	19	22	15.25	11.25	349	363	18
37.5	44	22	24	17.5	11.25	489	510	29
50	49	22	24	17.5	11.25	585	605	31
75	49	25	27	20	23.25	850	875	40
100	50	27	28	20	23.25	923	968	42
167	58	38	33	24	23.25	1475	1542	78
250	66	38	33	24	24	1820	1885	90
333	62	42	37	24	24	2040	2110	82
500	66	45	41	27	36	2850	2950	109
Type 'S' - Class 0A - 14400 /24940Y Primary Voltage								
KVA	A	B	C	D	E	Wgt	Ship Wgt	OIL Qty
10	38	17	20	13.25	11.25	205	217	11
15	38	17	20	13.25	11.25	245	256	11
25	46	22	24	17.5	11.25	455	470	29
37.5	46	22	24	17.5	11.25	505	526	28
50	51	25	27	20	11.25	730	755	41
75	52	25	28	20	23.25	910	936	38
100	56	27	28	20	23.25	985	1025	46
167	56	38	33	24	23.25	1430	1495	70
250	68	38	33	24	24	1865	1930	91
333	61	42	35	24	24	1970	2041	75
500	72	45	39	27	36	2960	3055	121

All Approximate Dimensions shown reference designs with +/- 2.5% Taps

## Transformer Protection Package for Overhead Distribution Transformers

Power Partners offers four basic transformer types: S, SP, CP and CSP®. Together they represent a wide range of protective capabilities to meet nearly every application. For transformers supplied with overcurrent protection, the user must assure coordination with system protective devices. Failure to do so will defeat the purpose of such protection.



Type S

### Conventional “S” Transformers

This type transformer contains no protection equipment. Therefore, lightning, fault and overload protection for these transformers must be provided by purchaser-installed, auxiliary protective devices.

### Conventional “S” with Protective Link

The protective link is the least expensive device mounted in the transformer to protect the system from a defective transformer. Whenever there is an internal failure the resulting fault current will cause the protective link to blow, isolating the transformer from the primary feeder.

### Conventional “S” with Current-Limiting Fuse and Protective Link

Both the current limiting fuse and the protective link are fuses working together to give full range transformer protection against fault-current. The protective link interrupts any low fault current while the current limiting fuse protects against fault currents which exceed the interrupting rating of the protective link.

### Surge-Protecting “SP” Transformers

The “SP” transformers include transformer-mounted lightning arresters and internally-mounted high voltage protective links, but omit the internally-mounted low voltage circuit breaker. These transformers are used in locations where lightning is a problem. However, because the protective link protects the system only from outages due to internal transformer failure, overload protection, if desired, must be provided by external fuses.

### Current-Protecting “CP” Transformers

The “CP” transformers are equipped with the internally-mounted low-voltage circuit breaker and high voltage protective links, but *omit* the lightning arresters. These transformers are used in locations where lightning is not a problem. The arrester may be crossarm-mounted if surge protection is desired.

The breaker and protective link are coordinated such that any fault or short circuit on the secondary side of the transformer will trip the breaker before the protec-

tive link operates, taking the load off the transformer before the core/coil is damaged.

### Current-Protecting “CP” Transformers with Current Limiting Fuse

This type transformer has the same characteristics as the type “CP” plus the ability to limit fault current to the transformer.

### Self-Protected “CSP”® Transformers

The CSP® coordinated protection package is available as an option on Power Partners overhead distribution transformers for increased protection against surge currents, short circuits, and overloads.



Type CSP®

### Features

1. Protective Link
  - a) Removes an internally-faulted transformer from the primary line.
  - b) Operates at 8 to 14 times normal full load current.
2. Secondary Circuit Breaker
  - a) Protects against overloads and external short circuits.
  - b) Coordinated with protective link, trips on an external short or overload before the link blows, and only if the overload is large or continuous.
  - c) If overload is small or temporary, a load management light signals the need for change-out to a larger unit for more optimized transformer loading.
3. MOV Polymer Arrester
 

Provides protection from lightning and switching surges.
4. Optional partial-range current limiting fuse (in series with protective link)
  - a) Limits the maximum current in the circuit.
  - b) Reduces current to zero in less than one-half cycle.
  - c) Minimizes the possibility of eventful failure.

The CSP® protection package is available on single phase and three phase overhead distribution transformers in the following ratings:

- Single Phase, IV 120/240, 10-100 kVA
- Single Phase, IV 240/480, 10-167 kVA
- Three Phase, 30-150 kVA

**Class Designations**

1. Type CSP®, above 5 kV, 10-100 kVA.

**Class A:** Two fully-insulated high voltage bushings, two arresters, two protective links and external breaker handle. Suitable for application on either wye or delta distribution systems. Single-position pole mounting in accordance with latest ANSI standards.

**Class B-1:** Two fully-insulated high voltage bushings, one arrester, two protective links and external breaker handle. Normally applied on solidly grounded systems.

**Class B-2:** One fully-insulated high voltage bushing, one arrester, one protective link and external breaker handle. Suitable only for application on solidly grounded distribution systems. Single-position pole mounting in accordance with latest ANSI standards.

**Class B-3:** Same as class B-2 except with two-position mounting.

2. Type CSP®, 5 kV and below, 10-100 kVA. Similar to Type CSP® above 5 KV except:

- Sidewall-mounted primary bushings.
- Class B-2 and B-3 not available.

1. Type S, above 5 kV, 10-500 kVA.

**Class A:** Two fully-insulated high voltage bushings, suitable for application on either wye or delta distribution systems. Single-position pole mounting in accordance with the latest ANSI standards.

**Class B-2:** One fully-insulated high voltage bushing, suitable only for application on solidly grounded distribution systems. Single-position pole mounting in accordance with the latest ANSI standards.

**Class B-3:** Same as class B-2 except with two-position mounting.

2. Type S, 5 kV and below, 10-500 kVA. Similar to Type S, above 5 kV, except:

- Sidewall-mounted primary bushings.
- Only Class A is available.

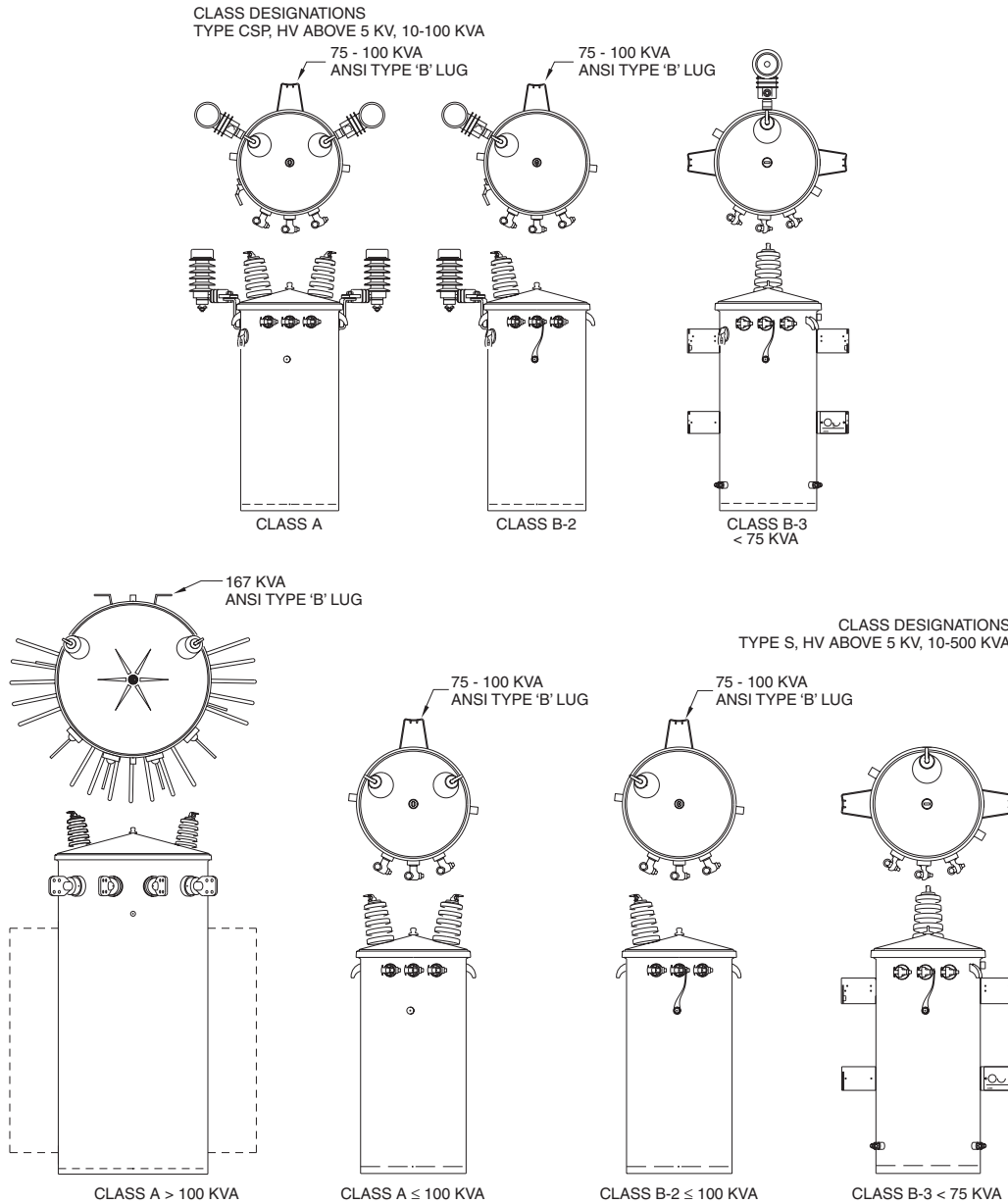

## Center-Bolt Cover Design

The exclusive center-bolt cover design is standard on all Power Partners overhead transformers, 5-500 kVA single phase and 30-500 kVA three phase. The cover assembly is unique in both operation and design. The unit offers an extraordinary high withstand capability and an extra margin of safety.

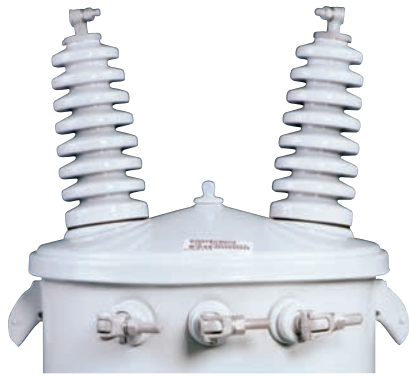

### Advantages

- Static and dynamic pressure relief provided by unique venting and resealing capability.
- Increased safety provided through higher tank withstand capability and automatic pressure venting during cover removal.
- No auxiliary pressure relief device is required.
- Extra insulation provided by thick epoxy coating.
- Increased resistance to corrosion provided by sloped cover and thick coating.
- Increased resistance to leaks and breathing provided by unique gasketing system.
- Simplified maintenance provided by single cover bolt.

### Features

1. Center-bolt cover, cover beam and beam support lug system provide:
  - a) Self-venting and resealing which meets ANSI specifications eliminating the need for an auxiliary pressure relief device.
  - b) Tank withstand capability in excess of the requirements of NEMA TR1.
2. Increased tank withstand capability and automatic pressure relief during cover removal result in increased safety.
3. Electrostatically-applied epoxy coating is a minimum of 13 mils, providing an average of 15 kV dielectric strength to provide extra insulation and protection from corrosion.
4. The 15° slope of cover prevents moisture from collecting and increases resistance to corrosion and leaking.
5. Continuous hollow nitrile gasket, raised and flat bushing embossments, undercut gasket seats on bushings, and copper-encased cover bolt gasket provide increased resistance to leaks and breathing.
6. Center cover bolt provides easy cover removal compared to chime ring design, resulting in lower maintenance cost.

### Standard Compliance

#### A. Pressure Venting and Resealing

The self-venting cover design meets the pressure venting and resealing requirements of ANSI C57.12.20-1997, paragraph 6.2.5.2.

“A cover assembly designed for relief of excessive pressure shall remain effectively sealed for overloads and external secondary short circuits of the magnitude and duration allowed by industry standards and loading guides, but shall relieve pressure at a minimum of 8 lbf/in<sup>2</sup>, gage (55.2 kPa) if designed to reseal; or at a minimum of 20 lbf/in<sup>2</sup>, gage (138 kPa) if designed for pressure relief without resealing. Such operation shall occur before other components of the tank are ruptured or displaced, and the cover shall remain in position. Manual means of venting the tank before removal of cover shall be provided.”

No auxiliary pressure relief device is required on Power Partners overhead distribution transformers. The flow rate of the center-bolt cover after venting is significantly higher than that of auxiliary pressure relief devices resulting in increased safety and higher tank withstand capability.



#### B. Tank withstand

The Power Partners overhead tank and cover design provide tank withstand capability far in excess of the requirements of NEMA TR1-2000, Part 2, Page 6, Section D:

“Test No. 1 – An Arcing Fault in an Enclosure”

“1. First Fault. A simulated internal fault shall be provided. This fault shall consist of a 1-inch arc gap mounted horizontally and located 1 inch above the core clamps. This gap shall be bridged initially by a 0.0605-inch diameter or smaller copper wire. The gap shall be connected between the high-voltage terminals or from one high-voltage terminal to ground. The mounting blocks or terminals of the gap shall consist of copper-bearing material and shall have flat surfaces from 1/2 to 3/4 inch in diameter or in width. These gaps shall be designed to maintain this 1-inch arc gap for the duration of the fault. The transformer coil shall not be electrically connected in this test circuit. The power source shall be 7.2 kV and adjusted to supply a current of 8000 rms symmetrical amperes.”

“As this arcing fault will not be self-clearing, back-up protection shall be provided to clear the circuit in approximately 1/2 to 1 cycle which is a typical clearing time for an external distribution fuse cutout. A cutout with up to a 25K fuse link shall be used to provide back-up protection. A current-limiting device, such as a fuse, cannot be included in the back-up protection.”

“2. Second Fault. For the second fault, the fault described in item 1 shall be repeated.”

This overhead tank and cover system can withstand a 20,000 Ampere one-inch arc on the specified test.

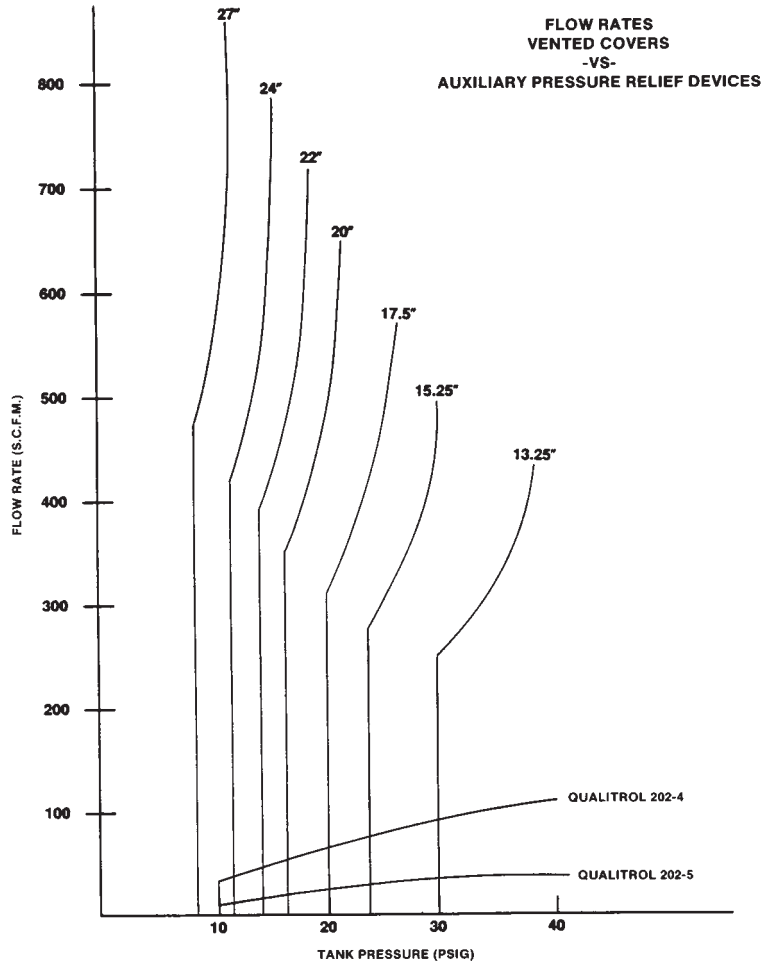

## Low Voltage Spark Gap

An internal low voltage spark gap has been developed as a means of protection for distribution transformers against secondary side surges. The Electric Utility Industry has been concerned about transformer failures attributed to secondary surges, although the failure rate is estimated to be less than 0.5% per year. The entire subject is very complex, but the phenomenon is very much related to system parameters, such as, house and pole ground resistance, length and type of service drop, and transformer load. The surge impedance of the transformer coil is also a significant factor, resulting in units larger than 50 kVA being typically immune from this type of failure. The Power Partners spark gap will provide the same degrees of protection as any other method presently available, and at a significantly lower cost.



The spark gap mounted internally on the LV neutral bushing with the electrodes connected to the X1 and X3 bushings.

### Application

The spark gap is mounted internally between the low voltage line bushings and the low voltage neutral and is designed to arc over during low voltage surges to protect the transformer windings.

### Testing

Exhaustive testing has proven that (1) the internal spark gap operates under surge conditions to protect the transformer winding, (2) the arc is extinguished under high available fault current conditions, and (3) the operation of the internal spark gap, under maximum oil temperature conditions, and with a wide range of oil vapor to air ratios, does not result in the development of an unsafe condition. This extensive testing proves conclusively that the internal spark gap provides the same degree of protection as that provided by interlaced secondary windings, low voltage MOV arresters, and external spark gaps.

### Advantage

Effective – prevents low-side surge failures.

Cost effective – a spark gap is considerably lower in cost than the other suggested methods of prevention.

Reliable – a spark gap does not degrade the overall transformer or the system reliability.

Easy installation – the internal spark gap can be easily retrofitted onto existing transformers.

## JUMBO “Step Down” Overhead Distribution Transformer

“JUMBO” Distribution Transformers are designed as single phase, two-winding transformers—specifically for “Step-Down” applications.



### Standard Features

1. Lo-Hi-Lo coil design divides the short circuit force between two low-high spaces increasing the short circuit strength of the coil.
2. Two winding construction yields a much higher impedance than is characteristic of an auto transformer which helps limit the mechanical forces the unit must sustain during fault duty.
3. Progressively wound coils with adhesive resins on thermally upgraded insulating paper provide increased short circuit and thermal strength.
4. Sheet conductor in IV windings enables the electrical centers in the high and low to align themselves minimizing the vertical component of short circuit forces.
5. Reinforced core-coil assembly provides greater short circuit withstand capability.

6. Prototype testing insures the Jumbo design can meet industry short circuit standards and provide reliable service.
7. Self-venting and resealing cover eliminates the need for an auxiliary pressure relief device and offers increased safety through higher tank withstand.
8. ANSI support lugs (hanger brackets) are rod-welded to the tank wall for added strength.
9. Anodized aluminum laser inscribed nameplate offers longer term readability.
10. Lifting lugs are positioned directly opposite the cover beam support lugs, reducing the chance of the tank going out of round when lifted.
11. Cover mounted high voltage porcelain bushings with eyebolt terminals are mounted on flat embossments on the cover and have undercut gasket seats for improved sealing. The eyebolt connectors are cast bronze plated with tin.
12. Low voltage porcelain bushings with clamp-type terminals provide ease in making secondary terminations.
13. Arrester mounting pads are resistance welded to the tank wall, completely and uniformly filling the surfaces where pad and tank wall join, to provide greater strength.
14. The paint finish process applies a durable, corrosion resistant finish to the product. The finish meets or exceeds all the performance requirements of ANSI C57.12.28. The multi-step process includes an epoxy primer uniformly applied by cationic electrodeposition and a urethane top coat.

### Ratings

- 50-500 kVA
- 65°C Rise
- 60 Hertz standard, 50 Hertz optional
- High voltages: 7200, 14400 and 19920
- Low voltages: 2400, 4800, 7200, 7620, 7970

**Standard Design Dimensions and Weights**

JUMBO LIQUID IMMERSED OVERHEAD DISTRIBUTION TRANSFORMER  
 TYPE S, HV ABOVE 5 KV, > 100 KVA

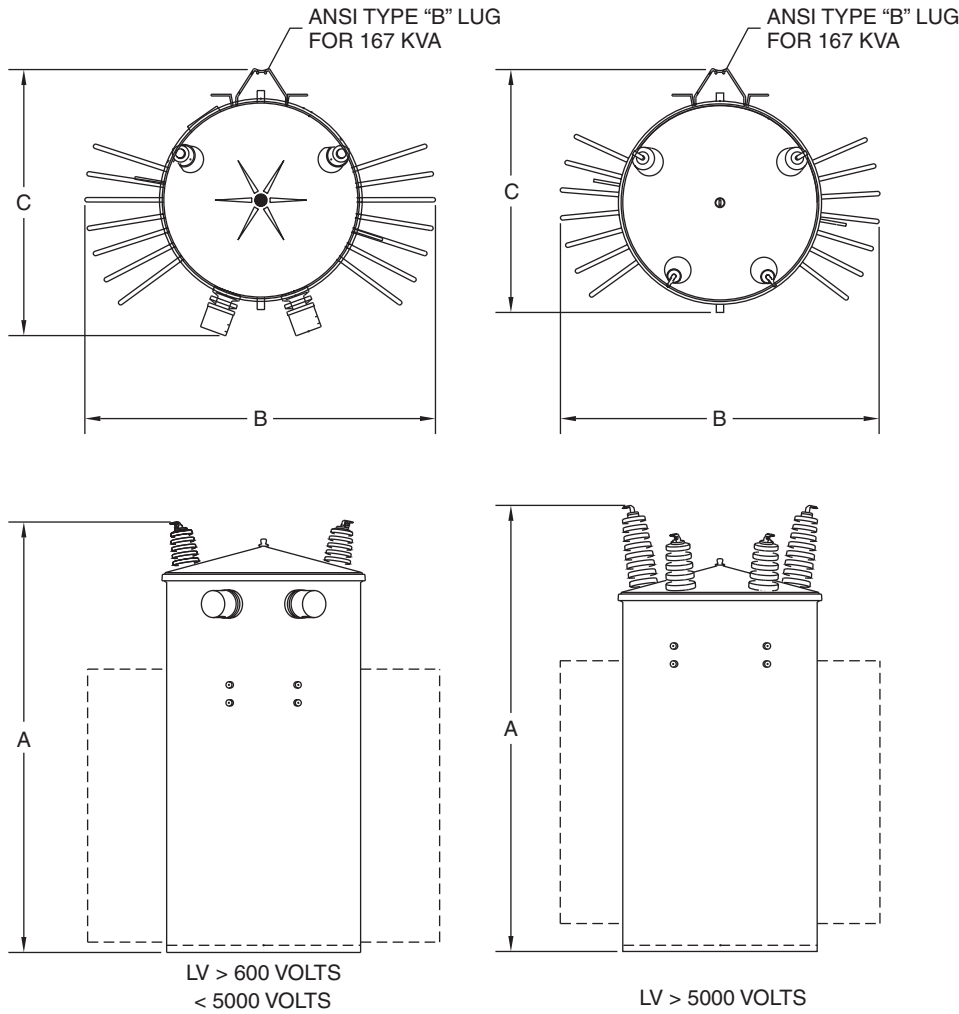

All Approximate Dimensions shown reference designs with +/- 2.5% Taps

KVA	A		B	C		D	Wgt	Ship Wgt	OIL Qty
	7200 HV	14400 HV		2400LV	7200LV				
	Jumbo								
50	45	47	24	28	25	20	750	785	36
75	Not Available								
100	45	52	31	31	31	22	1095	1150	50
167	58	52	33	37	33	27	2010	2090	88
250	54	56	41	37	33	27	2340	2440	85
333	54	64	45	37	33	27	2400	2500	88
500	69	68	45	39	36	27	3065	3165	120

Overall weights and dimensions are given in pounds, inches or gallons and are approximates  
 A = Overall Height, B = Overall Width, C = Overall Depth, D = Tank Diameter

## Three Phase Triplex Overhead Distribution Transformer

The Power Partners Triplex overhead distribution transformer can be used to serve three phase applications through 225 kVA. Triplex designs consist of three separate single-phase core-coil assemblies in one tank.



Triplex overhead distribution transformers are often used to serve large motor loads where the motors are frequently started. Oil field pumping loads and some irrigation pumping loads should use only triplex designs. Also, the Triplex transformer has international applications where Dy 5 and Dy 11 phase displacement are required.

### Ratings

- 30-225 kVA
- 65°C rise
- 60 Hertz standard, 50 Hertz optional
- High Voltages: 13800 and below
- Low Voltages: 208Y/120, 240 x 480, and 480Y/277
- Transformer BIL Ratings

Transformer Primary	Transformer BIL
2400	60 kV
4160	60 kV
7200	75 kV
8320	75 kV
12000	95 kV
12470	95 kV
13200	95 kV
13800	95 kV

### Advantages

- Easier, cleaner installations are provided by three phase overhead transformers compared to three single-phase units.
- Reduced installation costs, lower operating costs, safer operation, minimized service disruptions, and increased transformer life provided by an optional CSP protection package.
- The capability to serve large motor loads requiring frequent motor starting is provided by triplex designs.
- The same design, manufacturing and performance advantages that are provided on Power Partners single phase overhead distribution transformers are incorporated into the triplex design.

### Features

1. Wound core with step-lap joints for increased efficiency and lower noise levels.
2. Progressively wound coils with adhesive resins on insulating paper or conductors for increased short-circuit strength, efficiency and thermal strength.
3. CSP protection package available as an option for increased protection against surge currents, short circuits and overloads:
  - Primary protective links
  - Surge arresters
  - Secondary circuit breaker
  - Secondary breaker operating handle with emergency overload reset and overload signal light.
4. Three point core-coil bracing for increased mechanical strength.
5. Self-venting and resealing cover that eliminates the need for an auxiliary pressure relief device and offers increased safety through higher tank withstand.
6. The paint finish process applies a durable, corrosion resistant finish to the product. The finish meets or exceeds all the performance requirements of ANSI C57.12.28. The multi-step process includes an epoxy primer uniformly applied by cationic electrodeposition and a urethane top coat.
7. Cover has 13 mils minimum of polyester coating providing 15 kV dielectric insulation of tank ground parts from live parts and increasing resistance to corrosion. The cover is sloped 15° preventing water from collecting, thereby reducing the chances of corrosion and leaking.
8. Tank bottom rim is three layers thick for increased durability and resistance to shipping and handling damage.

**Standard Design Dimensions and Weights** (All weights and dimensions are approximate.)

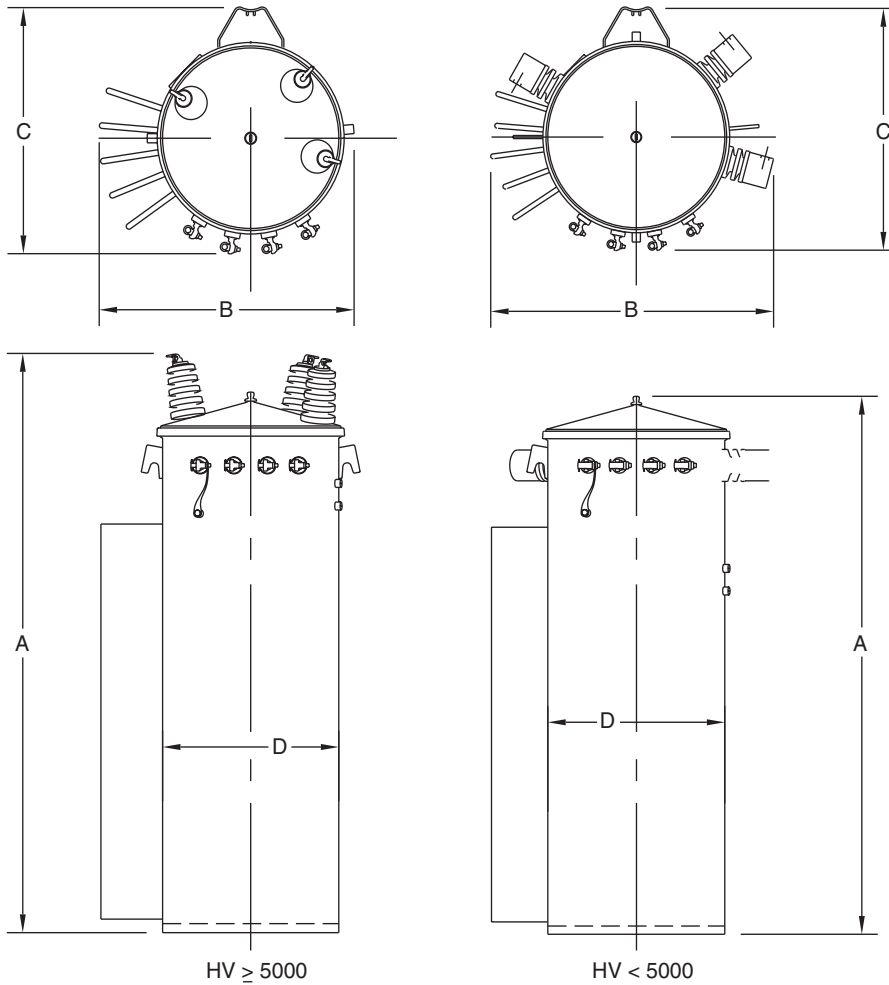

Overall weights and dimensions are given in pounds, inches or gallons and are approximate.  
 A = Overall Height, B = Overall Width, C = Overall Depth, D = Tank Diameter, E = Hanger Spacing

High Voltages 4160GY/2400, 7200GY/4160, 8320GY/4800								
KVA	A	B	C	D	E*	Wgt	Ship Wgt	OIL Qty
30	53	26	25	17.5	11.25	760	805	40
45	57	26	25	17.5	23.25	915	960	45
75	61	33	28	20	23.25	1120	1165	60
112.5	61	34	28	20	36	1540	1585	58
150	73	35	30	22	36	2455	2525	90
225	76	35	30	22	36	2650	2745	90
High Voltages 12470GY/7200, 14400GY/8320								
KVA	A	B	C	D	E*	Wgt	Ship Wgt	OIL Qty
30	58	23	25	17.5	11.25	760	805	40
45	62	23	25	17.5	23.25	920	965	45
75	66	29	28	20	23.25	1310	1355	60
112.5	66	34	28	20	36	1540	1585	58
150	78	31	30	22	36	2470	2540	90
225	81	31	30	22	36	2650	2745	90
High Voltages 20780GY/12000, 21590GY/12470, 22860/GY13200, 23900GY/13800								
KVA	A	B	C	D	E*	Wgt	Ship Wgt	OIL Qty
30	65	23	25	17.5	11.25	940	985	45
45	68	26	28	20	23.25	1290	1340	60
75	68	26	28	20	23.25	1340	1365	58
112.5	68	34	28	20	36	1540	1585	58
150	80	31	30	22	36	2470	2540	90
225	83	31	30	22	36	2650	2745	90

\*E is the distance between the hanger brackets.

## Three Phase “T-connected” Overhead Distribution Transformer

The Power Partners “T-connected,” overhead distribution transformer can be used to serve most three phase applications up to 500 kVA. “T-connected” transformers consist of two single-phase core/coil assemblies. This type of connection is also referred to as a “Scott-T” connection.

“T-connected”, overhead distribution transformers can be used to serve most three-phase applications. However, Triplex designed three phase transformers are needed for some applications where large motors are the load and these motors are frequently started. Oil field pumping loads and some irrigation pumping loads should use only the triplex designs.

### Ratings

- 30-500 kVA
- 65°C rise
- 60 Hertz standard, 50 Hertz optional
- High Voltages: 13800 and below
- Low Voltages: 208T/120, 240T x 480T, and 480T/277
- Transformer BIL Ratings

Transformer Primary	Transformer BIL
2400T	60 kV
4160T	60 kV
4800T	60 kV
7200T	75 kV
8320T	75 kV
12000T	95 kV
12470T	95 kV
13200T	95 kV
13800T	95 kV

### Advantages

- Easier, more economical and cleaner installations are provided by three phase overhead transformers compared to three single-phase units.
- Lighter weight and lower cost provided by “T-connected” design compared to conventional three-phase design.
- Elimination of overloads from system unbalance by operating “T-connected” transformers without primary grounds.
- Avoidance of transformer neutral requirement since third harmonic currents on “T-connected” transformers are negative sequence not requiring a ground path.
- Reduced installation costs, lower operating cost, safer operation, minimized service disruptions and increased transformer life provided by optional CSP coordinated protection package.
- The same design, manufacturing and performance advantages that are provided on Power Partners single phase overhead distribution transformers are incorporated into “T-connected” design.

### Features

1. Wound core with step-lap joints for increased efficiency and lower noise levels.
2. Progressively wound coils with adhesive resins on insulating paper or conductors for increased short-circuit strength and thermal strength.
3. Three point core-coil bracing for increased mechanical strength.
4. CSP protection package available as an option for increased protection against surge currents, short circuits and overloads:
  - Primary protective links
  - Surge arresters
  - Secondary circuit breakers
  - Secondary breaker operating handle with emergency overload reset and overload signal light.
5. Self-venting and resealing cover that eliminates the need for an auxiliary pressure relief device and offers increased safety through higher tank withstand.
6. The paint finish process applies a durable, corrosion resistant finish to the product. The finish meets or exceeds all the performance requirements of ANSI C57.12.28. The multi-step process includes an epoxy primer uniformly applied by cationic electrodeposition and a urethane top coat.
7. Cover has 13 mils minimum of polyester coating providing 15 KV dielectric insulation of tank ground parts from live parts and increasing resistance to corrosion. The cover is sloped 15° preventing water from collecting, thereby reducing the chances of corrosion and leaking.
8. Tank bottom rim is three layers thick for increased durability and resistance to shipping and handling damage.

**Standard Design Dimensions and Weights** (All weights and dimensions are approximate.)

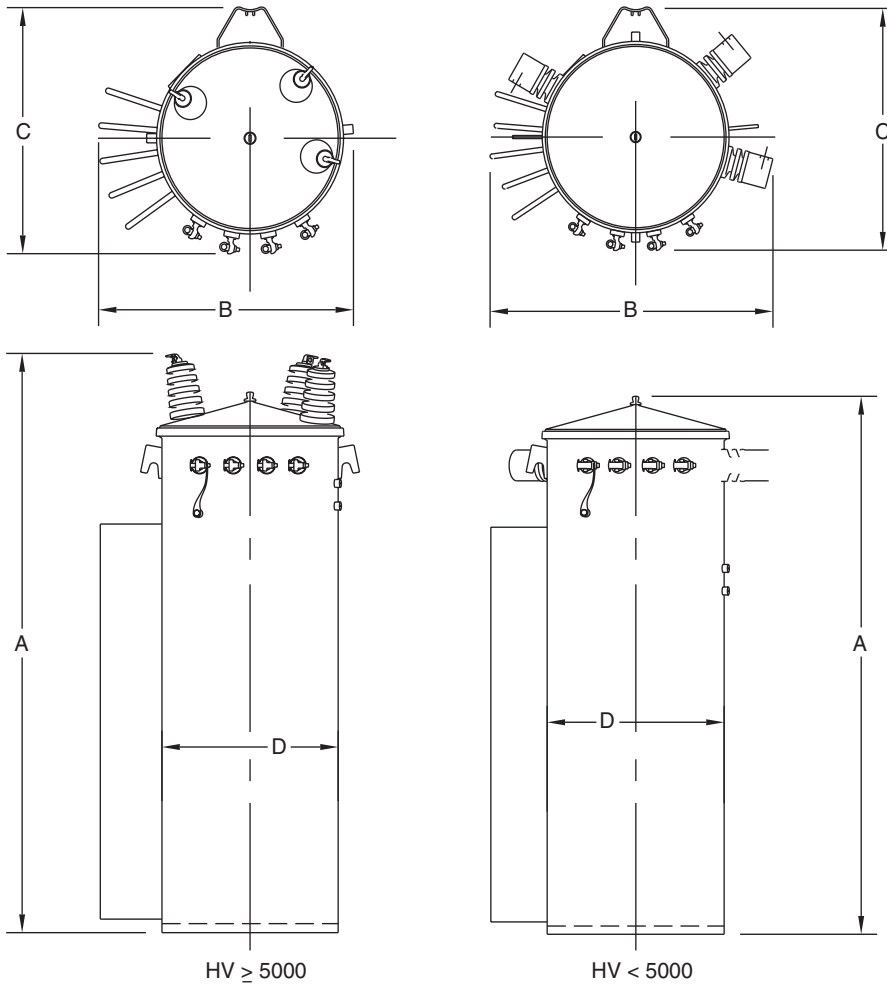

Overall weights and dimensions are given in pounds, inches or gallons and are approximate  
 A = Overall Height, B = Overall Width, C = Overall Depth, D = Tank Diameter, E = Hanger Spacing

3 Phase T - T Connected								
High Voltages 2400T, 4160T, 4800T								
KVA	A	B	C	D	E*	Wgt	Ship Wgt	OIL Qty
30	49	26	25	17.5	11.25	685	720	35
45	49	29	28	20	23.25	990	1035	44
75	49	33	28	20	23.25	1100	1175	52
112.5	57	31	30	22	36	1530	1625	62
150	57	40	30	22	36	1770	1840	70
225	61	37	34	24	36	2215	2303	81
300	64	41	36	27	36	2750	2860	98
500	78	45	42	27	36	3560	3650	118
High Voltages 12000T, 12470T, 13200T, 13800T								
KVA	A	B	C	D	E*	Wgt	Ship Wgt	OIL Qty
30	54	23	25	17.5	11.25	700	735	38
45	54	29	28	20	23.25	905	965	43
75	54	33	28	20	23.25	1175	1225	50
112.5	62	33	30	22	36	1505	1565	59
150	62	40	30	22	36	1725	1780	65
225	61	37	34	24	36	2285	2275	84
300	69	41	36	27	36	2915	3015	100
500	80	45	42	27	36	3815	3900	123

\*E is the distance between the hanger brackets.  
 All Approximate Dimensions shown reference designs with +/- 2.5% Taps

## Distribution Transformer Testing

The Power Partners commitment to manufacture quality distribution transformers is backed by a series of transformer tests used to verify conformance to performance characteristics outlined in the latest revisions of ANSI C57.12.00 and ANSI C57.12.90. These identified tests are also part of the Quality System which is audited semi-annually by DET NOSKE VERITAS (DNV) to the ISO Standards.

### Testing Program

Factory tests are performed on a transformer to confirm that it is properly designed and constructed to carry rated load and that it will withstand the conditions it will be exposed to in service.

Each transformer manufactured by Power Partners must undergo a series of tests.

1. Polarity, Phase-Relation, and Ratio
2. Applied Voltage Test of the HV
3. Applied Voltage Test of the LV
4. Induced Voltage Test
5. No-Load (Excitation) Loss and Excitation Current
6. Circuit Breaker Test (for CSP transformers only)
7. Impedance Voltage and Load Loss
8. Full Wave Impulse
9. Continuity Check

### Test Facilities

The multi-station, automated test facilities are operated by process control computers. Required interaction with test floor personnel is minimal with the computers initiating and monitoring each test, and then analyzing the test results feedback. The computers are programmed to conduct tests according to ANSI standards, and according to the ratings of each transformer style, the test floor computers will initiate appropriate test setups, compare results with established ANSI standard limits, and determine acceptance for each tested unit.

The test results for each unit are recorded and stored on computer files for access and analysis.

### Polarity, Phase-Relation, and Ratio Tests

These tests verify proper phase-relation (three phase), ratio, and polarity (single phase) of the transformer under test. To pass, a unit must demonstrate the proper polarity or phase-relation and have a turns ratio within one-half of one percent of the nominal voltage ratio.

### Applied Voltage Test of the HV

This test checks the dielectric integrity of insulation structures between the high voltage and low voltage, and between the high voltage and ground. A pass/fail decision is made by monitoring the test current intensity. If the resulting current is larger than specified normal leakage and capacitive currents, the unit is rejected. This test is omitted for transformers with a permanently grounded high voltage winding.

### Applied Voltage Test of LV

This dielectric test is similar to the Applied Voltage test of the high voltage circuitry except that the integrity of insulation structures between the low voltage and the high voltage, and between the low voltage and ground is checked. A pass-fail decision is made by monitoring the test current intensity. If the resulting current is larger than specified normal leakage and capacitive current, the unit is rejected.

### Induced Voltage Test

The principal purpose of this test is to verify the dielectric strength of turn to turn, layer to layer, phase to phase, and other insulation structures within the transformer windings by inducing an overvoltage condition (at higher than normal frequency to avoid saturation of the core). The test current is monitored, and if it exceeds limits specified for each transformer, the unit is rejected.

### No-Load Loss and Excitation Current

This test measures the no-load (excitation) loss and the transformer exciting current with rated voltage applied. If the exciting current and/or the no-load loss exceed the limits specified, the transformer is rejected.

### Circuit Breaker Test (for CSP transformers only)

This test verifies the proper operation of the low voltage circuit breaker under fault conditions. The breaker is required to operate within a specified time under a simulated fault.

### Impedance Voltage and Load Loss

This test measures the load loss and the impedance voltage at rated current. The load loss and the impedance voltage must be within specified limits.

### Full Wave Impulse

The impulse test is one of several tests designed to verify the dielectric strength of the many insulation structures within the distribution transformer against line voltage surges. It is performed to comply with ANSI standards and for quality assurance. The change in the ANSI standard in 1993 required all manufacturers to install fault detection sensitive enough to detect a single turn short.

### Continuity Check

This test is performed on all transformers to verify transformer circuit and component integrity. This test is performed with an ohmmeter to verify that the internal wiring is correct.

The transformer's nameplate is compared to manufacturing information for style, serial number, kVA, HV rating, LV rating, tap voltages, impedance, conductor materials and coil BIL rating. The bushings, electrical accessories, and fuses are verified.

## Special Tests

Some tests are performed at the option of the customer.

### Sound Testing

ANSI standards define the required sound levels for transformer but some customers specify reduced sound levels. The sound generated by a transformer is affected by the core geometry, flux density, tank design, and the quality of assembly of all the transformer components into a completed unit. Sound tests are made with the unit powered at 100% and 110% of rated voltage under no-load conditions.

### Temperature Tests

Core losses and coil losses are the primary sources of heating within the transformer. Our transformers are guaranteed to have an average coil winding temperature of no more than 65° C rise over ambient air temperature when operated at rated voltage and load conditions.

The temperature test is performed to determine the thermal characteristics of the transformer and to verify that they are within design limits.

### Calibration

Test equipment is calibrated on a scheduled basis by trained technicians. Calibration records are maintained in accordance with the Quality System procedures. These are audited semi-annually by DNV in accordance with ISO.

### Short Circuit Withstand Capabilities

Distribution transformers are subjected to external short circuits on the secondary side. Such external faults can develop on the service line, in the house wiring or in connected loads due to numerous environmental reasons. These faults can be line-to-ground, double line-to-ground or line-to-line.

To meet these operating conditions, the American National Standard Institute (ANSI) has set standards concerning short circuit withstand capability. These standards require that distribution transformers shall be designed and constructed to withstand the mechanical and thermal stresses produced by these external short circuits.

The current standards relating to short circuit strength are ANSI C57.12.00 which sets the short circuit withstand requirements for distribution transformers and ANSI C57.12.90 which provides procedures for short circuit testing.

For distribution transformers, the magnitude of the short circuit current, the numbers of short-circuit tests and the duration of each short circuit test are defined by ANSI standards as follows.

### A. Magnitude

Category	Single Phase kVA	Three Phase kVA	Withstand Capability*
I	5-25	15-75	40
	37.5-100	112.5-300	35
	167-500	500	25
II		750-2500	1/Z <sub>T**</sub>

\*Base current (Symmetrical) per unit for all distribution transformers with secondary rated 600 V and below.  
 \*\*The short circuit current will be limited by the transformer impedance only.

### B. Number of Tests

Each phase of the transformer shall be subjected to a total of six tests, four with symmetrical fault currents and two with asymmetrical fault currents.

### C. Duration of Short Circuit Tests

When short circuit tests are performed the duration of each test shall be 0.25 s except that one test satisfying the symmetrical current requirement shall be made for a longer duration on distribution transformers. The duration of the long test in each case shall be as follows:

Category I:

$$T = 1250/I^2$$

Where T is the duration in seconds,

And  $I = I_{sc}/I_R$  = symmetrical short circuit current, in multiples of normal base current except I shall not exceed the maximum symmetrical current magnitudes listed in A.

Where  $I_{sc} = I_R Z_T$  = symmetrical short circuit current, in rms amperes

$I_R$  = rated current on the given tap connection, in rms amperes

$Z_T$  = transformer impedance on the given tap connection in per unit on the same apparent power base as  $I_R$

Category II:

$$T = 1.0 \text{ second}$$

### Criteria of Satisfactory Performance

According to ANSI Standards a unit is considered to have passed the test if it passes a visual inspection and dielectric tests. Recommended additional checks include examination of wave shape of terminal voltage and current, leakage impedance measurement and excitation current test. (Refer to ANSI C57.12.90.)

The standard allows the following variations in the leakage impedance:

Z <sub>T</sub> (Per Units)	Percentage Variation
0.0299 or less	22.5-500 (Z <sub>T</sub> )
0.0300 or more	7.5

Z<sub>T</sub> = per unit impedance of the transformer

## Paint Finish Process

The Power Partners factory utilizes a paint finish process called “2CEC”, a trademark for a two-coat cathodic electrodeposition paint process. This new advanced coating technique maintains the structural integrity of transformers that are subjected to the long-term corrosive environments of coastal areas and industrial contaminants.

### Paint Process

Cathodic electrodeposition of paint occurs when direct current is applied to positively charged resin micelles dispersed in water. The resin micelles migrate toward the cathode (transformer tank) and are deposited in a process known as electrophoresis. As the process continues, the thickness of the deposit builds, resistance increases, and the film reaches a thickness limit. The most accessible areas are coated first, but as the resistance increases, less accessible areas coat, producing a highly uniform film build. Two-coat cathodic electrodeposition is the application of two coats of paint (epoxy primer/acrylic urethane topcoat).

### Paint Pretreatment

Prior to welding to the tank shell, stamped external hardware such as hanger brackets and lifting lugs are vibratory finished to remove burrs and insure a smooth radius edge to allow consistent edge coating.

An eight-stage dip process provides two cleaning steps to completely remove lubricants and soils. A zinc phosphate coating is applied to enhance corrosion protection by providing tighter, more consistent coating than the typically used iron phosphate. The use of deionized water in the final rinse stages insures that the surface is free of salts and ions that could later provide sites for corrosion initiation. All pretreatment stages are immersion stages, which assures complete and total coverage.

The electrodeposition process assures complete and consistent coverage of the entire tank including complex shapes such as fins, hanger brackets, and lifting lugs.

The “2CEC” process allows us to optimize the performance of the primer and topcoat independently to maximize corrosion protection and ultraviolet light resistance while maintaining superior mechanical properties.

Paint process consistency is assured through automated paint feed and monitoring of a real time basis. Paint system operators monitor and audit the process.

### Advantages of the Process

1. Complete and uniform coverage of complex shapes, including edges and corners, hanger brackets, ground pads, and tank bottoms.
2. Access into partially closed areas, such as inside the hanger brackets.
3. High solids film eliminates sagging problems.
4. Minimal organic solvent content.

### ANSI C57.12.28 Performance Requirements

ANSI Standard C57.12.28 served as the benchmark for performance on the tests listed below. The test results clearly indicate the two-coat cathodic electrodeposition to be a leader in corrosion resistance, while maintaining excellent performance in all areas of the ANSI standard. “2CEC” passed all the tests listed here.

### Salt Spray Test

Panels are scribed to bare metal and tested for 1000 hours in a 5% salt spray per ASTM B117-85E1 and evaluated per ASTM D1654-79A. Loss of adhesion from bare metal must not exceed more than 1/8" from the scribe. Underfilm corrosion must not exceed more than 1/16" from the scribe.

### Crosshatch Adhesion Test

Panels are scribed to bare metal with a crosshatch pattern and tested per ASTM D3359-83. There must be 100% adhesion to the bare metal and between layers.

### Humidity Test

Panels must be tested for 1000 hours in accordance with ASTM D2247-86A. There must be no blisters.

### Impact Test

Test panels were impacted per ASTM D2794-84 at 160 in.-lbs. of impact. There must be no chipping of the paint on the impact side of the test panel.

### Oil Resistance Test

Oil resistance testing is conducted at both 100°C and ambient for 72 hours. There must be no apparent changes, such as color shift, blisters, loss of hardness, or streaking.

### Ultraviolet Accelerated Weathering Test

Test panels must be exposed for 500 hours in accordance with ASTM G53-84. Loss of gloss must not exceed 50% of the original gloss as described in ASTM D523-85E1.

### Abrasion Resistance—Taber Abraser Test

The total coating system must be tested using a CS-10 wheel, 1000-gram weight, in accordance with ASTM D4060-84. The number of abrasion required to wear the coating through to the substrate must be at least 3000 cycles.

The ANSI C57.120.28 test results clearly indicate the two-coat cathodic electrodeposition is a leader in corrosion resistance while maintaining excellent performance in all areas of the ANSI standard. The two-coat cathodic electrodeposition maintains consistent, uniform paint coverage over the entire product, with no runs or sags, and offering a superior coating on distribution transformers.

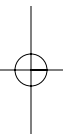
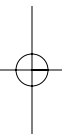
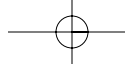

**Power Partners**  
Overhead Transformers  
200 Newton Bridge Road  
Athens, GA 30607  
Phone 706-548-3121  
July, 2003

ISO Certified  
July, 2003

